

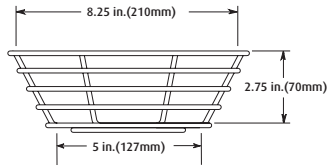

**Safety Technology International, Inc.**  
 2306 Airport Road • Waterford, Michigan 48327-1209  
 Phone: 248-673-9898 • Fax: 248-673-1246  
 Toll Free: 800-888-4784 • E-mail: info@sti-usa.com  
 Web: www.sti-usa.com

**Safety Technology International (Europe) Ltd.**  
 Unit 49G Pipers Road • Park Farm Industrial Estate • Redditch  
 Worcestershire • B98 0HU • England • Tel: 44 (0) 1527 520 999  
 Fax: 44 (0) 1527 501 999 • Freephone: 0800 085 1678 (UK only)  
 E-mail: info@sti-europe.com • Web: www.sti-europe.com



STI-9601  
STI-9601-SS

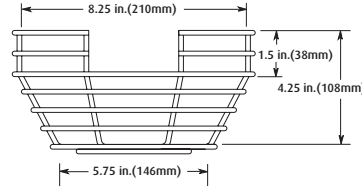

STI-9602

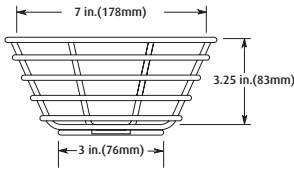

STI-9604  
STI-9604-SS

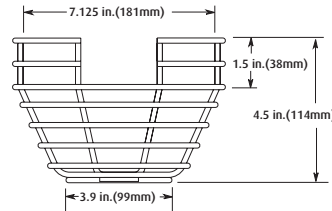

STI-9605  
STI-9605-SS

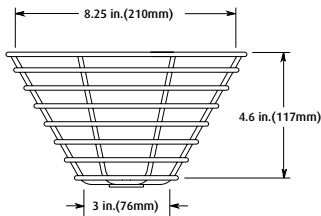

STI-9609  
STI-9609-SS

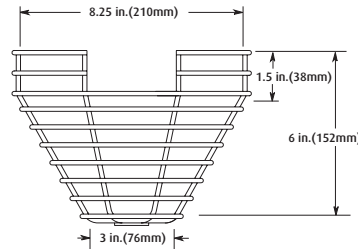

STI-9610

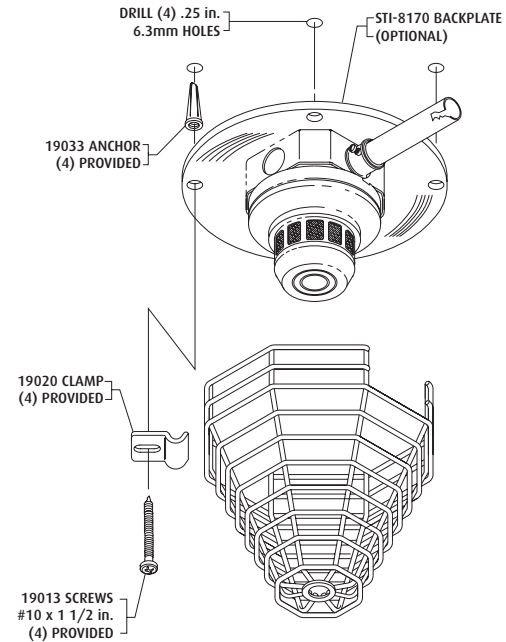

**IMPORTANT:**

Do not attempt to install the wire guard until the smoke sensor has been tested and in proper working order according to the manufacturer's installation instructions furnished with the sensor unit.

**INSTALLATION:**

1. Center the wire guard over existing smoke detector.
2. Mark and drill (4) mounting holes (see pictorial for size). Insert anchor into ceiling. **NOTE:** If lag shields and lag bolts are used, make sure anchor is flush with surface. Position guard, insert lag bolts and tighten. Length of bolt should be selected to assure full thread engagement in anchor.
3. STI-8170 BACKPLATE - STI recommends the use of this plate on all unstable mounting surfaces.
4. Insert screws through clamps and backplate (if used) and screw into anchors; but do not tighten.
5. Position guard over detector, slide clamps onto top wire of guard and tighten screws.

**SERVICE:**

1. Periodic cleaning of the smoke detector is required so dust and other matter do not accumulate.
2. To service the smoke sensor unit, loosen but do not remove the (4) screws, rotate clamps, and carefully remove wire guard.

**OPTIONAL ACCESSORIES:**

1. SUB-82 - #8 X 1 1/2" spanner tamper resistant stainless steel screw kit
2. 19038 - #8 spanner bit with 5/16 hex drive

**INSTALLATION OF STI CEILING MOUNTED SMOKE DETECTOR GUARDS**

All specifications and information shown were current as of publication, and are subject to change without notice.

## ADDITIONAL WIRE GUARDS AVAILABLE

Visit [www.sti-usa.com](http://www.sti-usa.com) for complete details

### SMOKE DETECTOR COVERS

STI-9601	Low profile - Flush mount	STI-9609-SS	High profile - Flush mount - Stainless Steel
STI-9601-SS	Low profile - Flush mount - Stainless Steel	STI-9610	High profile - Surface mount
STI-9602	Low profile - Surface mount	STI-9712	Photoelectric - Surface mount
STI-9604	Mini - Flush mount	STI-9713	Photoelectric - Flush mount
STI-9604-SS	Mini - Flush mount -Stainless Steel		
STI-9605	Mini - Surface mount		
STI-9605-SS	Mini - Surface mount - Stainless Steel		
STI-9609	High profile - Flush mount		



STI-9601

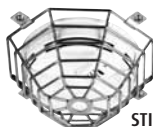

STI-9604-SS

### PIR GUARDS

STI-9618	Corner Mount
STI-9619	Corner Mount
STI-9620	6.25 x 4 x 2.25"
STI-9621	7 x 5.75 x 4.50"
STI-9622	8.75 x 4 x 3.75"



STI-9618



STI-9621

### EXIT SIGN WIRE CAGES

STI-9640	10.5 x 13.75 x 2.75"
STI-9740	15.5 x 20.5 x 6"



STI-9640

### EMERGENCY LIGHT CAGES

STI-9641	10.7 x 14.6 x 4"
STI-9644	8.7 x 17.7 x 5"
STI-9645	13.8 x 21.7 x 5.9"
STI-9649	10.75 x 24.75 x 11.25"
STI-9703	5 x 13.5 x 4"

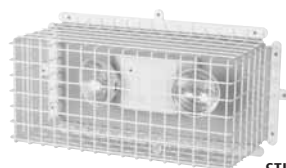

STI-9649

### MISCELLANEOUS WIRE CAGES

STI-9651	Fluorescent Light Damage Stopper®
STI-9717	Speaker/Strobe Damage Stopper® - Flush
STI-9720	Speaker Strobe Damage Stopper® - Surface
STI-9796	Outdoor Light Damage Stopper®
STI-9880	Fluorescent Lighting Damage Stopper® - Small
STI-9881	Fluorescent Lighting Damage Stopper® - Large



STI-9717



STI-9796

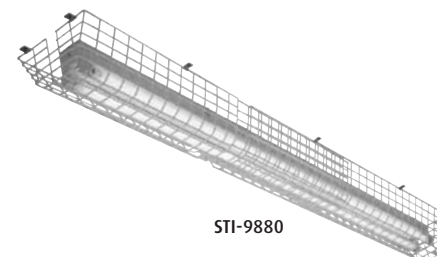

STI-9880

### BEAM SMOKE DETECTORS

STI-9623	For DS240 and DS241
STI-9624	For Fireway 50/100R
STI-9625	For System Sensor Beam Smoke Detector 6424
STI-9706	Flush Mount
STI-9707	Surface Mount



STI-9624



STI-9625

### CLOCK/BELL WIRE CAGES

STI-9631	10.5" Diameter
STI-9631-SS	10.5" Diameter - Stainless Steel
STI-9631-R	10.5" Diameter - Red
STI-9632	16.5 Diameter
STI-9632-SS	16.5 Diameter - Stainless Steel
STI-9633	20" Diameter



STI-9632

### BAY LIGHT WIRE CAGES

STI-9702	For Hubbell® Superbay Lights - 21.43 x 22.50"
STI-9709	For Hubbell® Superbay Lights - 24.5 x 26"



STI-9702

### BEACON & SOUNDER CAGES

STI-9614	7.9 x 6"
STI-9615	3.7 x 3.5"
STI-9617	5.9 x 4.9"
STI-9664	3.86 x 6.18"
STI-9665	7 x 8.43"



STI-9615



STI-9664