

SPECIFICATION

Input	Standby	Operating
9VDC	< 14µA	0.95A
12VDC	< 180µA	0.96A
24VDC	< 170µA	0.49A

Operating Temperature
-4°F to 140°F (-20°C to 60°C)

BATTERY INSTALLATION/REPLACEMENT

1. Unscrew lens to remove.
2. Loosen PCB screws (do not remove).
3. Gently rotate PCB without touching LED's and without damaging the reflectors.
4. Connect battery and slide under retainer.
5. Re-install PCB and tighten screws.

NOTES

1. Internal battery will provide backup power if loss of external power.
2. If no internal battery is used, remove all power and move S2-1 to "OFF" position (see detail S2).

LOW BATTERY OPERATOR

Replace battery when low battery condition occurs, Low battery LED flashes 1x per 1 minute and sounder beeps 1x per 3 minutes

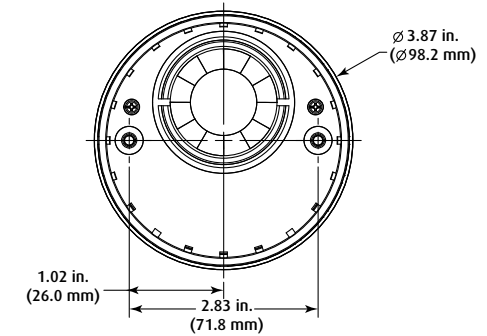
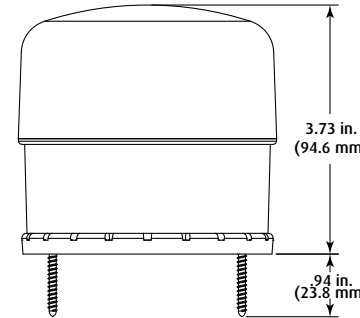

S2 - LOW BAT. NOTIFICATION/STROBE CONTROL

1	2	3	4	FUNCTION
1				LOW BATTERY NOTIFICATION ON
*	0			LOW BATTERY NOTIFICATION OFF
*	0	0	0	CONTINUOUS "ON"
	0	0	1	DOUBLE LED ROTATION
	0	1	0	3 FLASH - DELAY - 3 FLASH
	0	1	1	SINGLE LED ROTATION (FAST)
	1	0	0	FLASHING
	1	0	1	INTENSITY RAMPING UP & DOWN
	1	1	0	SINGLE LED ROTATION (SLOW)
	1	1	1	RIGHT/LEFT ROTATION

*Default Settings

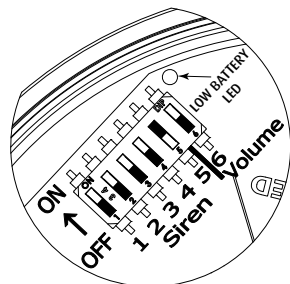

DETAIL S1
See pg. 2

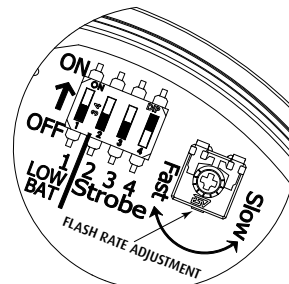
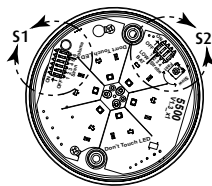

DETAIL S2

WARNING: This product can expose you to chemicals including Dichloromethane, which is known to the State of California to cause cancer, and Bisphenol A (BPA), which is known to the State of California to cause birth defects or other reproductive harm. For more information go to www.P65Warnings.ca.gov.

Three year warranty or a one year limited warranty (from date of purchase) on most products. See website for details. Electronic warranty form at www.sti-usa.com/wc14.

INSTALLATION OF STI-SA5500 SELECT ALERT SIREN/STROBE

All specifications and information shown were current as of publication and are subject to change without notice.

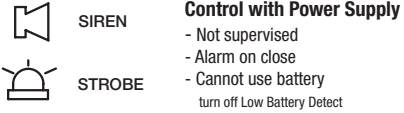

Control with Power Supply

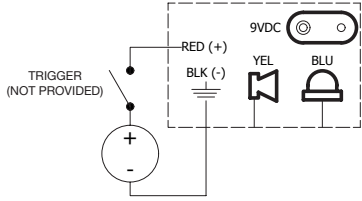

STROBE ONLY

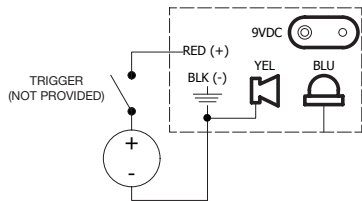

SIREN ONLY

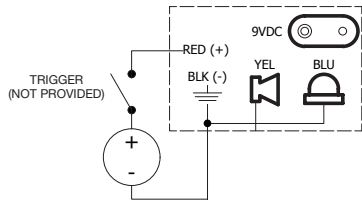

Power Supply Plus Battery

- Supervised trigger
- Alarm on open trigger
- Low battery alert
(Turn off if battery not used)

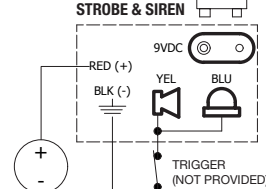

STROBE ONLY

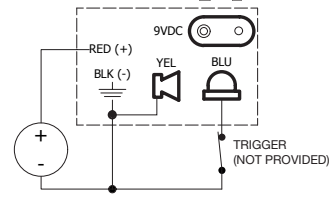

SIREN ONLY

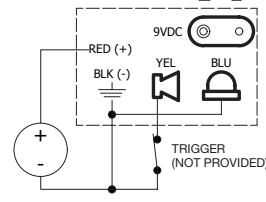

Battery Only

- Supervised trigger
- Alarm on open trigger
- Low battery alert

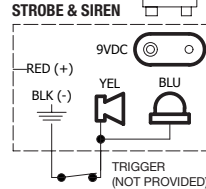

STROBE ONLY

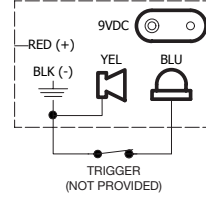

SIREN ONLY

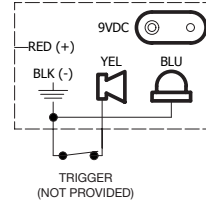

S1 ALARM TONES

1	2	3	4	5	FUNCTION
* 1	1	1	1	1	1800Hz - 3300Hz @ 150ms
0	1	1	1	1	500Hz - 1200Hz, 0.5s/ 0.5s OFF x 3/1.5s OFF (AS1670 EVACUATION)
1	0	1	1	1	520Hz, 0.5s / 0.5s OFF x 3/1.5s OFF (FIRE)
0	0	1	1	1	1200Hz - 500Hz @ 1Hz (DIN 33 404)
1	1	0	1	1	500Hz - 1200Hz, 3.75s ON / 0.25s OFF (AS2220)
0	1	0	1	1	550Hz/440Hz @ 0.5 Hz
1	0	0	1	1	970Hz, 0.5s/ 630Hz, 0.5s
0	0	0	1	1	800Hz / 1000Hz 0.5s each (1Hz)
1	1	1	0	1	1500Hz - 2700Hz @ 3Hz
0	1	1	0	1	800Hz / 970Hz @2Hz
1	0	1	0	1	800Hz, 0.25s ON/ 1s OFF
0	0	1	0	1	2400Hz - 2900Hz @ 9 Hz
1	1	0	0	1	750Hz
0	1	0	0	1	970Hz
1	0	0	0	1	970Hz, 1s OFF/1s ON
0	0	0	0	1	500Hz - 1200Hz, 3.5s ON/ 0.5s OFF (NEN 2575:2000 DUTCH SLOW WHOOP)
1	1	1	1	0	800Hz - 970Hz @1Hz
0	1	1	1	0	1000-2500Hz, 0.5s/ 0.5s OFF x 3/1.5s OFF (AS1670 EVACUATION)
1	0	1	1	0	2850Hz, 0.5s ON/0.5s OFF x 3/1.5s OFF (ISO 8201)
0	0	1	1	0	660Hz 1.8s ON/1.8s OFF
1	1	0	1	0	500Hz - 1200Hz @ 0.33Hz
0	1	0	1	0	250Hz - 1200Hz @ 12Hz
1	0	0	1	0	2400Hz
0	0	0	1	0	800Hz - 970Hz @ 9Hz
1	1	1	0	0	510Hz, 0.25s/ 610Hz, 0.25s
0	1	1	0	0	550Hz, 0.7s/1000Hz, 0.33s
1	0	1	0	0	660Hz 0.15s ON/0.15s OFF
0	0	1	0	0	800Hz - 970Hz @ 3Hz
1	1	0	0	0	420Hz 0.625s ON/0.625s OFF (AUSTRALIA AS1670 ALERT TONE)
0	1	0	0	0	554Hz, 0.1s/440Hz, 0.4s (AFNOR NF S 32 001)
1	0	0	0	0	970Hz, 0.5s ON/0.5s OFF x 3/1.5s OFF (ISO 8201)
0	0	0	0	0	2400Hz - 2900Hz @ 3 Hz

S1 VOLUME

6	FUNCTION
* 1	High volume
0	Low volume

* Default Settings

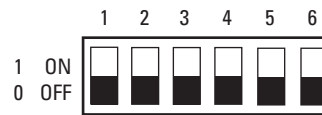

INSTALLATION OF STI-SA5500 SELECT ALERT SIREN/STROBE

All specifications and information shown were current as of publication and are subject to change without notice.